

**BRUKSANVISNING  
INSTRUCTION MANUAL**

# **NAMRON PANELOVN WiFi**

## **1500W/2000W**

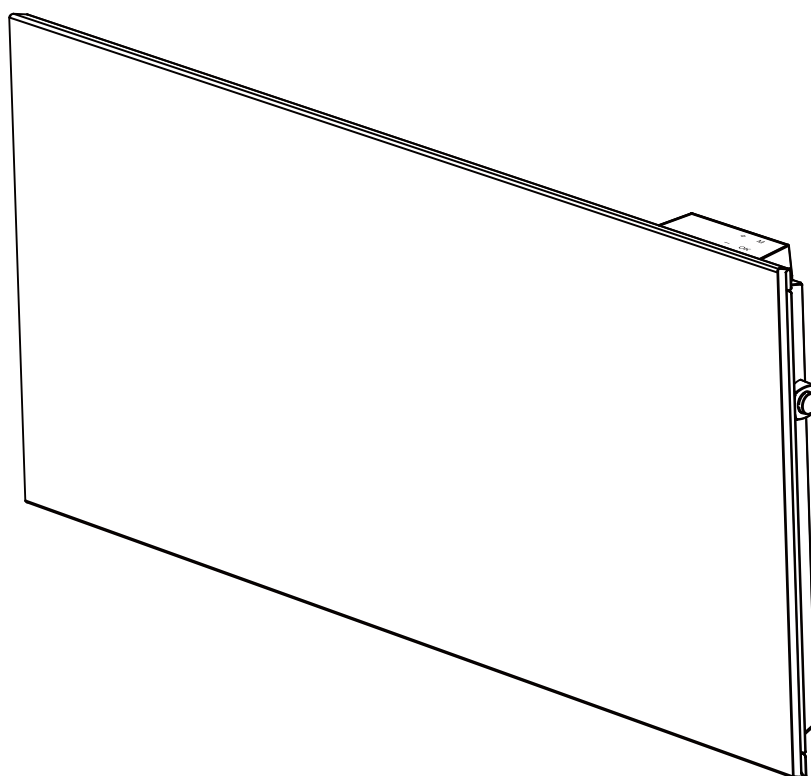

# NAMRON PANELOVN WiFi 1500W/2000W

# namron

220-240V~ 50-60Hz IP24



Effekt: 1500W/2000W  
Spenning: 220-240V~50-60Hz  
Tetthetsgrad: IP24  
Frekvens: 2.4GHz (2.412-2.472GHz)  
RF ledet effekt: 18dBm  
Inkludert 1,6 m kabel og støpsel.

Effect: 1500W/2000W  
Operating voltage: 220-240V~50-60Hz  
IP Rating: IP24  
Frequency: 2.4GHz (2.412-2.472GHz)  
RF conducted power: 18dBm  
Included 1.6 m cable and plug.

## BRUK / USE

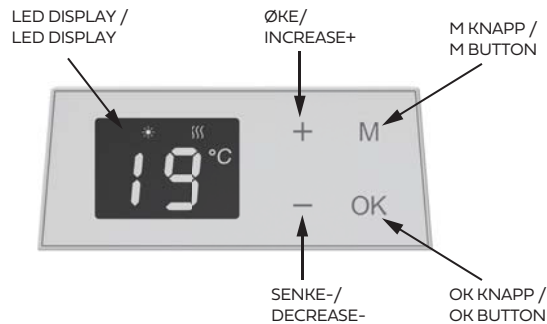

## BRUK MED WIFI

1. Sett inn strømpluggen og slå på strømbryteren. Skjermen vil vise temperaturen.
2. Velg "OF"-modus ved å trykke på "OK"-knappen og holde knappen inne til "OF"-symbolet vises på skjermen.
3. Hold "OK" inne i mer enn 5 sekunder, deretter vil WiFi ikonet blinke.
4. Se nedenfor QR-koden for "Wifi-veiledning".



## USE WITH WIFI

1. Insert the power plug and turn on the power switch. The display will show the temperature.
2. Choose "OF" mode by pushing the "OK" button, hold the button until "OF" symbol is shown on the display.
3. Keep pressing "OK" more than 5 seconds, then the WiFi icon will flash.
4. Refer to below QR code for "Wifi Guide".



## BRUK UTEN WIFI

1. Sett inn strømpluggen og slå på strømbryteren. Skjermen vil vise temperaturen.
2. Velg Komfort modus (viser "NR") eller ECO modus (viser "EL") ved å trykke på "OK"-knappen og holde knappen inne til "NR" eller "EL"-symbolet vises på skjermen.
3. Når omgivelsestemperaturen er lavere enn innstilt temperatur, vil varmeovnen starte oppvarming automatisk. Varmeikonet vil vises på skjermen.
4. Trykk på "+" eller "-" for å stille inn ønsket temperatur. Temperaturen kan justeres mellom 5-35°C. Trykk og hold inne "+" eller "-" for å justere temperaturen raskere.  
Fabrikkinnstillingen er KOMFORT = 21 °C, ECO = 17 °C.
6. Trykk "OK" for å velge "OF" for å sette apparatet i standby modus.

## WITHOUT WIFI

1. Insert the power plug and turn on the power switch. The display will show the temperature.
2. Choose Comfort mode (display "NR") or ECO mode (display "EL") by pushing the "OK" button, hold the button until "NR" or "EL" symbol on the display.
3. When the environment temperature is below set temperature, the heater will start heating automatically. The heating icon will be shown in the display.
4. Press "+" or "-" to set the desired temperature. The temperature can be adjusted between 5-35°C. Press and hold "+" or "-" to adjust the temperature in a faster speed.  
Factory default setting is COMFORT = 21°C; ECO = 17°C.
6. Press "OK" to select "OF" to turn the appliance into standby.

## BRUK MED PROGRAM

### 1) TIDSINNSTILLING

1. Trykk på "M"-knappen for å velge "td" og trykk kort på "OK"-knappen. Varmeovnen vil gå til menyen for tid.
2. Trykk på "+" / "-" for å stille inn ukedagen (velg fra d1 til d7). Trykk "OK" for å lagre og gå til innstilling for time.
3. Trykk på "+" / "-" for å stille inn timen på dagen (velg fra 0 til 23). Trykk "OK" for å lagre og gå til innstilling for minutt.
4. Trykk på "+" / "-" for å stille inn minuttene (velg fra 00 til 59). Trykk "OK" for å lagre.  
Varmeovnen vil gå tilbake til arbeidsmodus og temperaturinnstillingen.

## USE WITH PROGRAM

### 1) TIME SETTING

1. Press "M" button to select "td" and short press "OK" button. The heater will enter Time setting interface.
2. Press "+" / "-" to set the day of the week (choose from d1 to d7). Press "OK" to save and enter hour setting.
3. Press "+" / "-" to set the hour of the day (choose from 0 to 23). Press "OK" to save and enter minute setting.
4. Press "+" / "-" to set the minute (choose from 00 to 59). Press "OK" to save.  
The heater will go back to the working mode and temperature.

## 2) PROGRAMVALG

Trykk kort på OK for å velge P1, P2, P3 eller P4.

### P1, P2, P3 forhåndsinnstilt programmodus

1. Trykk kort på OK for å velge P1, P2, P3 .
2. Etter å ha blinket i 5 sekunder, vil skjermen vise innstilt temperatur.

P1, P2 og P3 er forhåndsinnstilte programmer med følgende forhåndsinnstilte programmer:

Ukentlige moduser/ Weekly modes	P1 (5-2)	Mandag-Fredag/Monday-Friday				Lørdag-Søndag/Saturday-Sunday	
	P2 (6-1)	Mandag-Lørdag/Monday-Saturday				Søndag/Sunday	
	P3 (7-0)	Mandag-Søndag/Monday-Sunday					
	P4 (0-7)					Mandag-Søndag/Monday-Sunday	
Innstilling av tid og program/ Time and program setting	Begivenhet/Event	4 oppvarmingssykluser/4 heating cycles				2 oppvarmingssykluser/2 heating cycles	
	Tidsperiode/ Time period	Komfort/Comfort	Eco	Komfort/Comfort	Eco	Komfort/Comfort	Eco
	Tid / Time	6:00-9:00	9:00-16:00	16:00-23:00	23:00-6:00	7:00-23:00	23:00-7:00
	Fabrikkinnstilling/ Factory setting	21°C	17°C	21°C	17°C	21°C	17°C

## 2)PROGRAM SELECTION

Short press OK to choose P1 or P2 or P3 or P4.

### P1 or P2 or P3 pre-set program mode

1. Short press OK to select P1 or P2 or P3.
2. After flashing 5 seconds, the display will show set temperature.

P1,P2,P3 are default program with pre-set program as below:

### P4 er et programmerbart ukentlig

Hvis du ønsker å endre P4-programmet, følger du trinnene nedenfor:

1. Trykk kort på M-knappen og velg Pr.
2. Trykk OK-knappen for å gå inn i P4-programmet.
3. Etter å ha kommet inn i P4-programmet:  
Trinn 1, sett ukedagen, skjermen viser d1, trykk + eller - for å velge d1/d2/d3/d4/d5/d6/d7. Trykk OK-knappen for å bekrefte.  
Trinn 2, sett timen på dagen, skjermen viser 0H, trykk + eller - for å velge KOMFORT eller ECO. Trykk OK-knappen for å bekrefte.  
KOMFORT modusen fungerer ved KOMFORT modusens temperatur.  
ECO modusen fungerer ved ECO modusens temperatur.  
Du kan endre temperaturen for KOMFORT og ECO ved å følge trinnene i BRUK UTEN WIFI" Nr. 2.
4. Gjenta de ovennevnte trinnene for å stille inn de gjenværende dagene og timene i uken. Trykk OK for å bekrefte. Skjermen vil blinke i 30 sekunder, og deretter gå tilbake til Pr-programmet. Pr-programmet vil blinke i 10 sekunder. Dette betyr at innstillingen er fullført. Varmeovnen vil følge programmet du har satt.

\*Kontroll av hele programmet du har satt

Trykk på M-knappen og velg Pr, trykk og hold inne + og - knappen samtidig i 5 sekunder, skjermen vil rulle ut hele ukens program du har satt. Etter det vil den returnere til td-grensesnittet og blinke i 10 sekunder. Deretter vil varmeovnen gå tilbake til arbeidsmodus.

### P4 is a Customized weekly program

If you want to revise the P4 program, follow below steps:

1. Short press M button and choose Pr.
2. Press OK button enter P4 interface.
3. After entering P4 interface:  
Step 1, set day of the week, display show d1, press + or - choose d1/d2/d3/d4/d5/d6/d7.Press OK button to confirm.  
Step 2, set the hour of the day, display show 0H, press + or - choose COMFORT or ECO . Press OK button to confirm.  
The Comfort mode works at the temperature of Comfort mode.  
The ECO mode works at the temperature of ECO mode.  
You can change the temperature of Comfort and ECO following steps in Use without wifi" No.2.
4. Repeat above steps to set the rest day and hours of the week. Press OK to confirm. Display will flash 30s and then back to the interface of Pr. Pr interface will flash 10s. It means the setting is complete. The heater will work the program you have set.

\*Checking of the whole program that you have set

Press M button and choose Pr, press and hold + and - button at the same time for 5s, the display will roll out with the whole week program you have set. After that, it will return to td interface and flash 10s. Then heater will be back to working mode.

### Kalibrer temperaturføler / Temperature calibration

Trykk kort på "M" for å velge "C". Trykk kort på "OK" for å gå inn i C - menyen for kalibrering av temperaturføler. "0" vil vises som standard på skjermen. Trykk på "+" / "-" for å stille inn kompensasjonstemperaturen innenfor  $\pm 5^{\circ}\text{C}$ .

Short press "M" to select "C". Short press "OK" to enter C — temperature calibration setting interface. "0" will show on the display as default. Press "+" / "-" to set the compensation temperature within  $\pm 5^{\circ}\text{C}$ .







### Adaptiv start/ Adaptive start

Trykk kort på "M" for å velge "AS". Trykk "OK" for å gå inn i menyen for adaptive start. Skjermen vil vise "on" eller "oF". Trykk på "+" eller "-" for å endre valget. Når "on" er valgt, er Adaptiv start aktivert. Når "oF" er valgt, er funksjonen deaktivert. Standardinnstillingen er "oF". Denne funksjonen beregner hvor lang tid det tar å oppnå ønsket temperatur og aktiverer varmeovnen i god tid for å sikre at "komfort"-temperaturen nås til oppgitt tidspunkt. Denne funksjonen kan slå på apparatet for oppvarming maksimalt 2 timer på forhånd.

**Merk: Denne funksjonen gjelder bare for P1, P2, P3-programmet.**

Short press "M" to select "AS". Press "OK" to enter Adaptive Start setting interface. The screen will show "on" or "oF". Press "+" or "-" to change the selection. When "on" is selected, the Adaptive Start function is activated. When "oF" is selected, the function is deactivated. Default setting is "oF". This feature measures the thermal inertia of the room and turns on the heaters in advance to ensure "comfort" temperature is reached at the set time. This function can turn on the appliance for heating maximum 2 hours in advance.

**Remarks: This function applies for P1, P2, P3 program only.**

<b>Minnefunksjon/ Memory function</b>	<p>Etter strømavbrudd kan varmeovnen huske den innstilte temperaturen før strømbruddet og fortsette å fungere. Ved strømbrudd vil varmeovnen opprettholde den interne klokken 24 timer i døgnet. Hvis strømmen er brutt i mer enn 24 timer, vil varmeovnen, når strømmen slås på igjen, gå tilbake til den sist brukte temperaturen, den interne klokken vil tilbakestilles til standardtid, og varmeovnen vil starte på nytt. Strømbrudd vil bli indikert av at skjermen blinker. Blinkingen vil fortsette til hvilken som helst av knappene trykkes på for å stoppe den.</p> <p>After the power is turned off, the heater can memorize the working set temperature before the power failure and continue to work. In the event of a power disconnection, the heater will keep the internal clock running 24 hours. If the power is disconnected for more than 24 hours, when the power is turned on again, the heater will return to the last used temperature, the internal clock will return to the default time and start running again. The screen will flash, indicating that there is a power outage. The blinking state will continue until any button is pressed to cancel the blinking.</p>
<b>Justering av skjermens lysstyrke/ Adjustment of display brightness</b>	<p>Trykk kort på "M" for å velge LI. Trykk "OK" for å gå inn i LI - innstillingsgrensesnittet for skjermlysstyrke. Du kan justere lysstyrken på skjermen. Standardinnstillingen er 3. Trykk på "+" / "-" for å velge mellom nivå 1 til 5. Nivå 1 er den mørkeste, mens 5 er den lyseste.</p> <p>Short press "M" to select LI. Press "OK" to enter LI—screen brightness setting interface. You can adjust the brightness of the screen. The default setting value is 3. Press "+" / "-" to choose from grade 1 to 5. Grade 1 is the darkest while 5 is the brightest.</p>
<b>Åpent-vindu-funksjon / Open window detection</b>	<p>Trykk og hold inne "+" og "OK" i fem sekunder for å gjøre innstillinger i Åpent-vindu-funksjonen. Åpent-vindu-ikonet  vil da blinke. Trykk deretter på "+" / "-" for å velge «Av» eller «På». Trykk "OK" eller vent i fem sekunder uten å trykke på noen knapper for å bekrefte innstillingen.</p> <p>Standardinnstillingen for denne funksjonen er Av. Når funksjonen er aktivert vil Åpent-vindu-ikonet  vises i displayet. Detekterer ovnen et temperaturfall, vil den automatisk gå over i antifrost-modus og operere på 7°C mens Åpent-vindu-ikonet  blinker. Om temperaturen stiger vil ovnen gå tilbake til forrige modus med Åpent-vindu-funksjonen på. Du kan også gå tilbake til forrige modus ved å trykke på en vilkårlig knapp. Velg «Av» for å deaktivere Åpent-vindu-funksjonen.</p> <p>Press and hold "+" and "OK" for five seconds to enter the open window detection settings. The open window icon  will be flashing. Then press "+" / "-" to choose «on» or «off». Press "OK" or after five seconds without operating the display, and the setting will be saved. The default factory setting for this function is off.</p> <p>If «on» is selected, the window detection function is activated and the open window icon  will be visible in the display. When temperature drop is detected, the appliance will automatically enter anti-freeze mode (heater works at 7°C, with open window icon  flashing). If temperature rises, the appliance will go back to previous working mode. You can also press any button to go back to previous mode. Choose «off» to deactivate the detection function.</p>
<b>Minnefunksjon ved strømbrudd / Memory function</b>	<p>Ovnen er utstyrt med minnefunksjon. Når strømmen returnerer vil ovnen gå tilbake til samme temperatur som før strømbruddet.</p> <p>The heater has a memory function and will automatically return to the desired temperature after a power cut.</p>
<b>Barnesikring / Child Lock</b>	<p>Trykk og hold inne "M" og "-" i fem sekunder til "CC" vises i displayet. Barnesikringen er da aktivert. Bruk samme fremgangsmåte for å deaktivere funksjonen. Når ovnen er tilkoblet en smarhub, kan barnesikringen aktiveres/deaktiveres derfra.</p> <p>Press and hold "M" and "-" for five seconds, until "CC" shows on the display. Child lock is now activated. Repeat procedure to deactivate this function. Child lock can also be activated / deactivated in your smart hub.</p>
<b>Tilbakestill til standardinnstilling / Reset the thermostat to default</b>	<p>Trykk på "+" and "M" og til "rE" vises i displayet. Ovnen går da tilbake til standardinnstillingen.</p> <p>Press "+", "M" button until display shows "rE", heater will be set back to the factory default setting.</p>
<b>Skru Av/På lyset i displayet / Light on /off the display</b>	<p>Trykk og hold inne "-" og "OK" i fem sekunder, og displayet vil blinke tre ganger. Etter 30 sekunder vil lyset i displayet skrus av. Skru på lyset i displayet ved å trykke på en hvilken som helst knapp.</p> <p>Press and hold "-" and "OK" for five seconds and the display will flash three times. After 30 seconds without being operated, the displays light will then turn off. Press any key to light it again.</p>
<b>Informasjon før førstegangs bruk / Information before first time use</b>	<p>Ovnen bør settes på maksimal temperatur i 30 minutter for å brenne elementet rent. Noe lukt kan oppstå når dette gjøres.</p> <p>The heater should be set to maximal temperature for 30 minutes to burn the element clean. Some smell may occur.</p>











**MÅ IKKE TILDEKkes/  
DO NOT COVER**























## SIKKERHET/SAFETY

Må ikke tildekkes, ovnens overflate kan bli svært varm og må plasseres i trygg avstand fra brennbart materiale. Koble fra strømmen ved vedlikehold. Ved bruk av skjøteledning må den være kortest mulig og rullet ut når ovnen er på.

Do not cover the heater surface, the heater can become very hot and must be placed at a safe distance from flammable material. Disconnect power during maintenance. If using an extension cord it must be as short as possible and be extended when the oven is on.

## IKONOVERSIKT / ICON OVERVIEW

	Funksjonen for vindusdeteksjon Window detector function		Standby Stand by
	KOMFORT modus Comfort mode		Temperatur Temperature
	ECO-modus Eco mode		Wi-Fi Wi-Fi
	Ikon for varmeindikator Heating indicator icon		Time Hour

	P4 (gratis ukentlig tilpasset program) P4 (free weekly personalized program)		I denne modusen blir apparatet ikke oppvarmet, men klokkeinnstillingene During this mode, the appliance doesn't heat up but clock settings are maintained.
	temperaturkalibrering temperature calibration		funksjonen for vindusdeteksjon vil være deaktivert the window detector function will be deactivated
	justering av skjermens lysstyrke adjustment of screen brightness		funksjonen for vindusdeteksjon vil være aktivert the window detector function will be activated
	tilpasningsstartfunksjon adaptive start function		fabrikkinnstilling factory default setting
	tidsinnstilling time setting		Mandag Monday
	KOMFORT modus Comfort mode		Tirsdag Tuesday
	ECO-modus ECO mode		Onsdag Wednesday
	forhåndsinnstilte programmer P1 fixed pre-set programs P1		Torsdag Thursday
	forhåndsinnstilte programmer P2 fixed pre-set programs P2		Fredag Friday
	forhåndsinnstilte programmer P3 fixed pre-set programs P3		Lørdag Saturday
	gratis ukentlig tilpasset program free weekly personalized program		Søndag Sunday

## MONTERING AV OVNEN/ASSEMBLY OF THE HEATER

- 1) Bor hull i vegg. Avstand mellom hull: Se skjema (a).
- 2) Skru fast festet på vegg.
- 3) Press ovnen på festet og skru fast.

- 1) Drill holes in the wall. Distance between holes: See the form (a).
- 2) Attach the clips onto the wall.
- 3) Push the heater into the clips and use screws to tighten the clips.

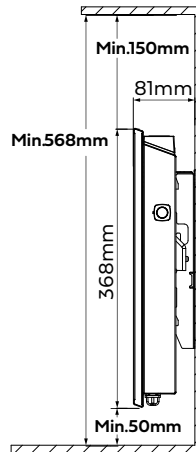
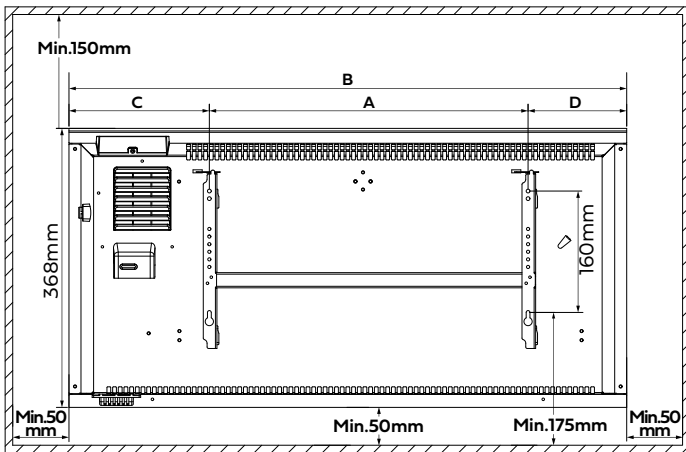

(mm)

Watt	A	B	C	D
1500W	420	945	290	235
2000W	490	1155	360	305

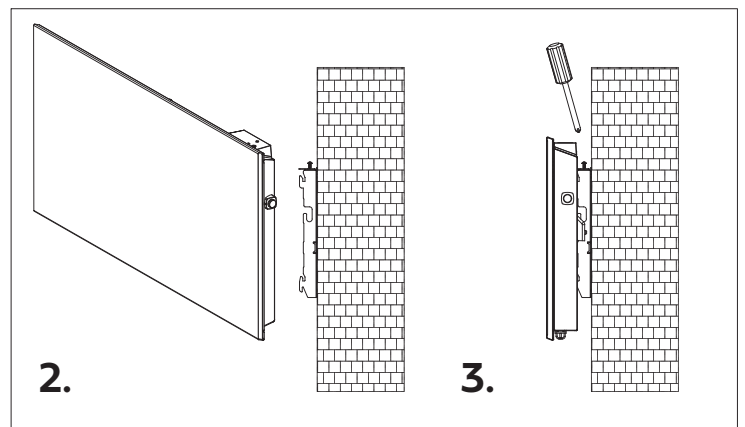
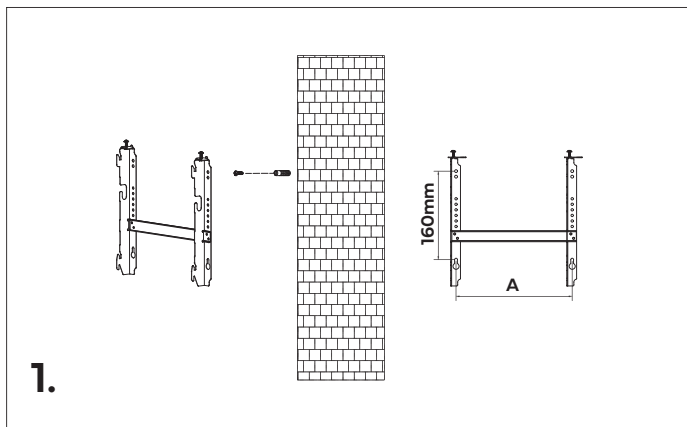
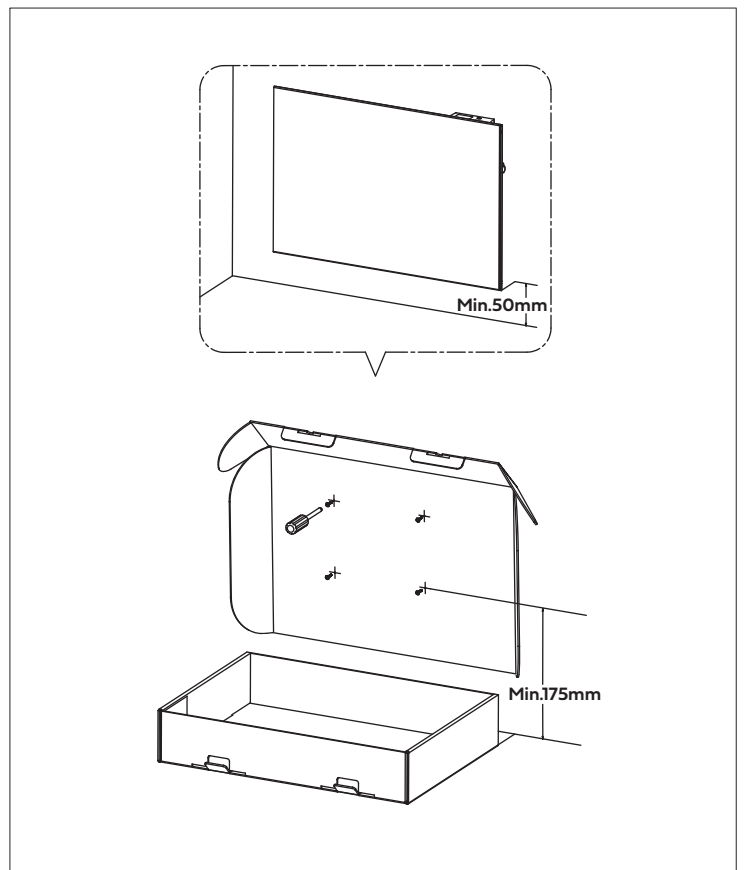
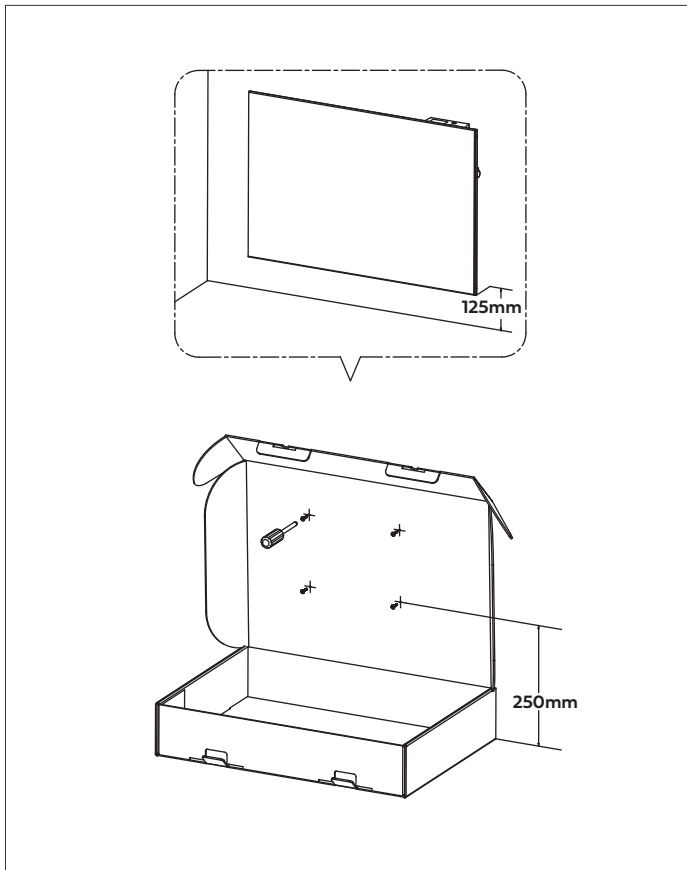

**MÅL / MEASURES**

**1500W**

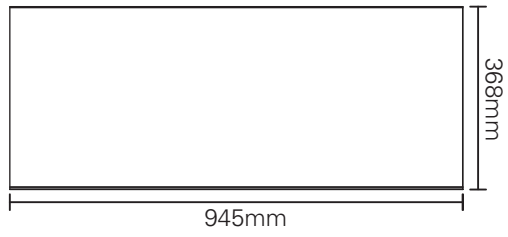

**2000W**

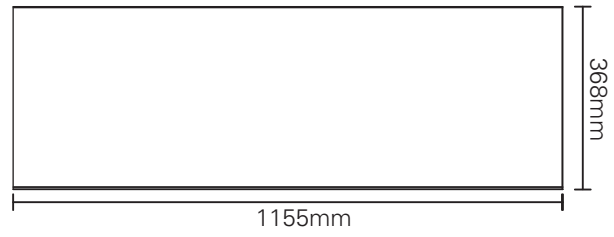

Model identifier(s): 5419619,5419620						
Item	Symbol	Value	Unit		Item	Unit
<b>Heat output</b>					<b>Type of heat input, for electric storage local space heaters only (select one)</b>	
Nominal heat output	$P_{nom}$	1.5	kW		manual heat charge control, with integrated thermostat	[no]
Minimum heat output (indicative)	$P_{min}$	N/A	kW		manual heat charge control with room and/or outdoor temperature feedback	[no]
Maximum continuous heat output	$P_{max,c}$	1.5	kW		electronic heat charge control with room and/or outdoor temperature feedback	[no]
<b>Auxiliary electricity consumption</b>					fan assisted heat output	[no]
At nominal heat output	$eI_{max}$	0	kW		<b>Type of heat output/room temperature control (select one)</b>	
At minimum heat output	$eI_{min}$	0	kW		single stage heat output and no room temperature control	[no]
In standby mode	$eI_{SB}$	0.00046	kW		Two or more manual stages, no room temperature control	[no]
					with mechanic thermostat room temperature control	[no]
					with electronic room temperature control	[no]
					electronic room temperature control plus day timer	[no]
					electronic room temperature control plus week timer	[yes]
					<b>Other control options (multiple selections possible)</b>	
					room temperature control, with presence detection	[no]
					room temperature control, with open window detection	[yes]
					with distance control option	[yes]
					with adaptive start control	[no]
					with working time limitation	[no]
					with black bulb sensor	[no]
Contact details	Namron AS Nedre kalbakkvei 88 1081 Oslo Norway post@namron.com					



Model identifier(s): 5419621,5419622					
Item	Symbol	Value	Unit	Item	Unit
<b>Heat output</b>				<b>Type of heat input, for electric storage local space heaters only (select one)</b>	
Nominal heat output	$P_{nom}$	2.0	kW	manual heat charge control, with integrated thermostat	[no]
Minimum heat output (indicative)	$P_{min}$	N/A	kW	manual heat charge control with room and/or outdoor temperature feedback	[no]
Maximum continuous heat output	$P_{max,c}$	2.0	kW	electronic heat charge control with room and/or outdoor temperature feedback	[no]
<b>Auxiliary electricity consumption</b>				fan assisted heat output	
At nominal heat output	$e_{lmax}$	0	kW	<b>Type of heat output/room temperature control (select one)</b>	
At minimum heat output	$e_{lmin}$	0	kW	single stage heat output and no room temperature control	[no]
In standby mode	$e_{lSB}$	0.00046	kW	Two or more manual stages, no room temperature control	[no]
				with mechanic thermostat room temperature control	[no]
				with electronic room temperature control	[no]
				electronic room temperature control plus day timer	[no]
				electronic room temperature control plus week timer	[yes]
				<b>Other control options (multiple selections possible)</b>	
				room temperature control, with presence detection	[no]
				room temperature control, with open window detection	[yes]
				with distance control option	[yes]
				with adaptive start control	[no]
				with working time limitation	[no]
				with black bulb sensor	[no]
Contact details	Namron AS Nedre kalbakkvei 88 1081 Oslo Norway post@namron.com				